

- (A) Colector drenaje 2"  
**2" Drainage manifold**
- (B) Colector entrada 8"  
**8" Inlet manifold**
- (C) Colector salida 8"  
**8" Outlet manifold**

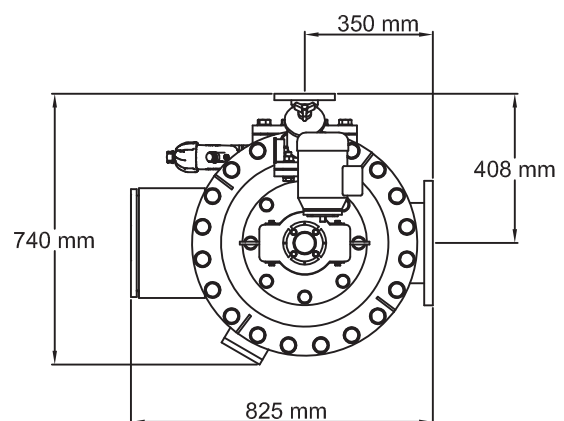

### AZUD LUXON LDB 8000 S/8

SCALE S/E A4 FORMAT	MATERIAL:	RESPONS.: M. Martínez	<b>AZUD</b>
	UNITS: mm.	REVISION: 00	
	FILE: Azud_luxon_LDB_8000-S8.dwg	04/05/2012	